

HEWLETT-PACKARD JOURNAL



AUGUST 1968



Fig. 1. Automatic phase lock, simplified controls, and absolute amplitude calibration make this new spectrum analyzer as easy to use and interpret as an oscilloscope. It has a frequency response that is flat within ± 0.5 dB over its range of 1 kHz to 110 MHz, a 70-dB spurious-free display range, -130 dBm sensitivity, scan widths up to 100 MHz, and nine calibrated IF bandwidths. Variable-persistence display is optional.

Fully Calibrated Frequency-Domain Measurements

With absolute amplitude calibration and unique ease of use, this 1 kHz-to-110 MHz spectrum analyzer may be the beginning of a new era in spectrum analysis.

By Brian D. Unter

SIGNAL ANALYSIS IN THE FREQUENCY DOMAIN has always been recognized as one of the more powerful techniques available to engineers for characterizing circuits and systems. In fact, engineers are trained to *think* in the frequency domain. Unfortunately, it has always been difficult to *measure* in the frequency domain. RF measurements below 110 MHz have always been limited by the equipment available, much of which is special-purpose, complex, and hard to use. Manually tuned wave analyzers, distortion analyzers, receivers, and uncalibrated spectrum analyzers all have limitations which prevent designers from making rapid and meaningful use of the frequency domain.

For the first time, a spectrum analyzer (Fig. 1) has absolute amplitude calibration combined with broad sweep capabilities, high sensitivity, low distortion, wide dynamic range, and flat frequency response. The new HP Model 8552A/8553L Spectrum Analyzer was designed to be a general-purpose measurement tool, to make the frequency domain as scope-accessible as the time do-

main. It was a central aim of the design to devise the controls and the display so they would be easy to use and interpret. Automatic frequency stabilization occurs during normal use of the instrument without preliminary adjustments. The display is free of clutter because a low-pass input filter prevents out-of-band signals from overloading the analyzer or causing confusing spurious responses. A red panel lamp warns the operator when the display becomes uncalibrated because the scan rate is too fast for the bandwidth selected.

The new spectrum analyzer was developed in the HP microwave laboratory for use in many electronic fields, especially those concerned with circuit design in communication systems. Its frequency range, 1 kHz to 110 MHz, is a span that includes audio, video, and IF amplifiers, navigational aids, telemetry, and most multiplex basebands, as well as commercial AM, FM, TV, and land mobile communications. The analyzer is useful for evaluating oscillators, frequency converters, amplifiers, filters, and numerous other system components. Impor-

tant design parameters that can be readily derived from its display are such things as modulation index, harmonic and intermodulation distortion, noise levels, spectral purity, residual FM, and frequency response.

Contributions to Spectrum Analysis

The new analyzer makes a number of contributions to spectrum analysis. The most significant ones are probably these five:

- Absolute amplitude calibration. Signal levels can be measured directly in voltage or power using the analyzer's LINEAR and LOG display modes. The procedure is similar to using an oscilloscope to measure voltage.
- Broad frequency range and wide-scan capability. Frequency range is 1 kHz to 110 MHz. Scan widths from 2 kHz to 100 MHz can be selected.
- Wide dynamic range. Distortion-free dynamic range is at least 70 dB, and it can be as high as 85 dB.
- High sensitivity. Maximum sensitivity is better than -130 dBm, or $0.07 \mu\text{V}$.
- Flat frequency response. Response is flat within ± 0.5 dB over the entire frequency range.

The article on page 8 describes some of the circuits and system techniques that give the analyzer these and other capabilities.

Another Kind of Oscilloscope

It seems likely that the new spectrum analyzer will be regarded as a *frequency-domain oscilloscope*. Waveforms which can be measured in the time domain with an ordinary oscilloscope can be measured just as easily and precisely in the frequency domain with the spectrum analyzer. For example, Fig. 2(a) is an oscilloscope display of the output of an amplifier overdriven by a 10-MHz signal. It is apparent that the output stage is limiting; the oscilloscope shows that distortion is present and gives clues to the nature of the distortion. However, quantitative measurement of the distortion is difficult. On the other hand, the frequency domain presentation of the same waveform, Fig. 2(b), clearly shows the levels of the second through the tenth harmonics in relation to the fundamental at 10 MHz. If α is the ratio of the fundamental V_1 to the n^{th} harmonic V_n , expressed in dB, the percentage of n^{th} harmonic distortion is given by

$$d_n = 10^{-\alpha/20} \times 100\%.$$

Using the analyzer's logarithmic display, the value of α can easily be found; it is just the level of V_1 in dBm minus the level of V_n in dBm. Notice that, since the analyzer is

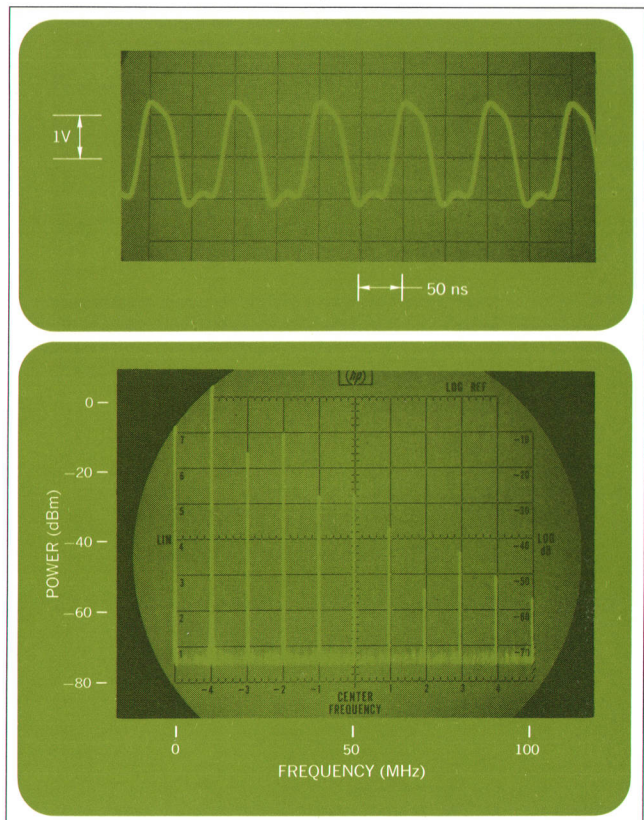

Fig. 2. Harmonic distortion in the output of an overdriven amplifier is obvious in the time domain (top), but is difficult to measure. Amplitudes of the second through the tenth harmonics are easily measured in the frequency domain (bottom), using the 100-MHz scan width of the new spectrum analyzer.

Cover: Model 8552A/8553L Spectrum Analyzer and Model 8601A Generator/Sweeper together are a powerful system for making frequency-domain measurements below 110 MHz. The cover photograph shows them measuring the frequency response of a low-pass filter. The generator/sweeper has been modified slightly to serve as a tracking generator for the spectrum analyzer. By the way, the instruments aren't battery-powered; the power cords are there, hidden in the grass.

In this Issue: Fully Calibrated Frequency-Domain Measurements; **page 2**. Analyzer/Tracking-Generator System; **page 4**. Design of a Third-Generation RF Spectrum Analyzer; **page 8**. New Concepts in Signal Generation; **page 15**. Units Ambiguity Noted; **back cover**.

Analyzer/Tracking-Generator System Has Amplitude Range of 120 dB

In measuring frequency responses of amplifiers and filters, there are considerable advantages to using the new spectrum analyzer as a receiver for an external tracking generator. The tracking generator takes outputs from the analyzer and produces a signal to which the analyzer is always tuned as it scans across the band of interest. Absolute signal level, gain, and frequency response of an amplifier, or bandwidth, flatness, and shape factor of a filter can be measured rapidly. The results of adjustments can be seen immediately. Displays can be broadband or narrowband, and have 70-dB range. *The amplitude dynamic range of such a system can be greater than 120 dB.*

A tracking generator which will cover the entire range of sweep widths from 2 kHz to 100 MHz is presently under development and will be available in early 1969. However, for those who want to use this powerful technique immediately, the tracking-generator connection in Fig. 1 is suggested.

Two outputs are taken from the spectrum analyzer RF plug-in — the THIRD LO and the FIRST LO. The THIRD LO output at a frequency of approximately 47 MHz is mixed with a stable 153-MHz source in the first mixer. The stability and settability of the signal generator phase-locked to a synchronizer makes the maximum sensitivity (-130 dBm) of the analyzer usable. The 200-MHz sum from the first mixer is sent through a bandpass filter to the 'R' port of the second mixer. If spurious 'birdie' markers are not objectionable, the bandpass filter may be omitted.

Connected to the 'L' port of the second mixer is the 200-to-310-MHz FIRST LO signal that has been amplified in a broadband amplifier. The difference frequency of 0 to 110 MHz appearing at the 'X' port is amplified and then attenuated for a good 50-ohm source match. The tracking-

generator output, at a level of approximately -6 dBm, can be connected to the RF input of the analyzer to test the flatness of the system or for amplitude peaking adjustments. The system shown is typically flat within ± 1.5 dB. (This will improve to ± 0.25 dB with the tracking generator now under development.)

To measure the frequency response of an amplifier or filter, just insert it between the tracking-generator output and the RF input of the analyzer.

Fig. 2 illustrates the 120-dB dynamic range of this system. Two photographs were taken of the response of a 20-MHz crystal filter for different gain settings of the spectrum analyzer. The photographs were then put together to show the 120-dB rejection band for the filter. While the filter's 60-dB bandwidth is about 6.6 kHz, it is easy to see the 80-dB bandwidth is more like 14.5 kHz. Notice the -127 dB zero in the stop band, 5.6 kHz to the right of the center frequency.

For applications requiring only broadband displays, 500 kHz to 100 MHz wide, a tracking generator can be made more simply using a modified HP Model 8601A Generator/Sweeper (see article, page 15) as shown in Fig. 3. The frequency response of the generator/sweeper is flat within ± 0.25 dB across the full band. Hence fine variations in amplitude of a few tenths of a dB can be displayed on the analyzer in the LINEAR mode. Filter adjustments can be made quickly while looking at the passband ripple and the stop-band attenuation.

Tracking generators were used almost exclusively in the design of the filters in the new spectrum analyzer. In that sense, the analyzer helped generate itself after the first prototype was built.

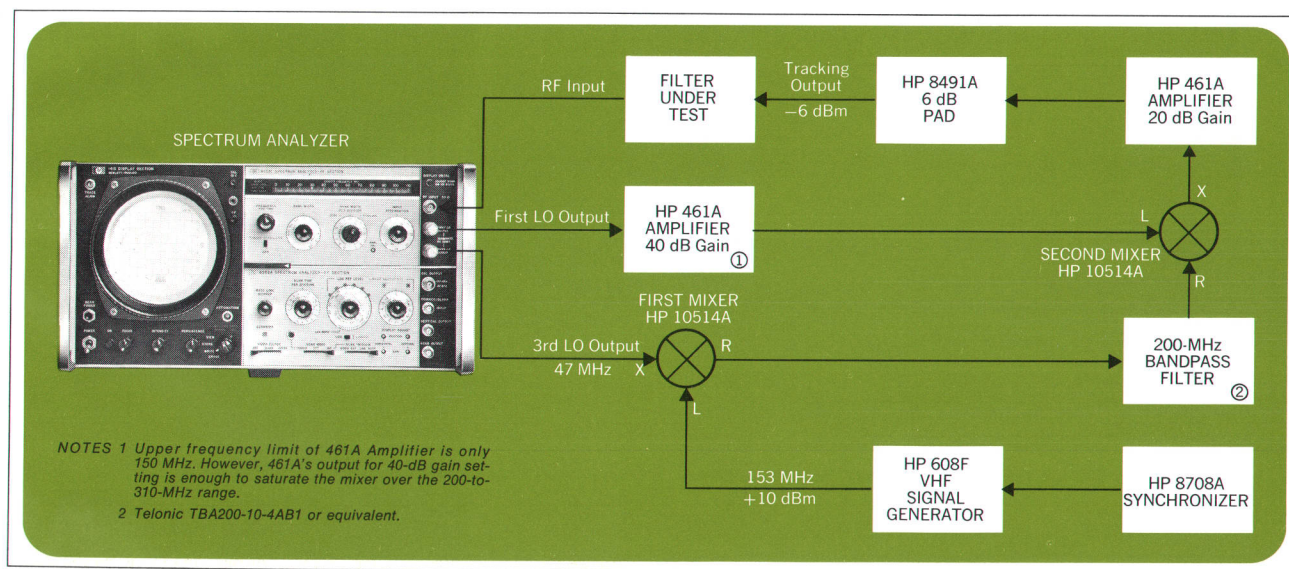

Fig. 1. Spectrum analyzer with tracking-generator system for measuring frequency responses. Amplitude range is greater than 120 dB. Frequency range is 1 kHz to 110 MHz.

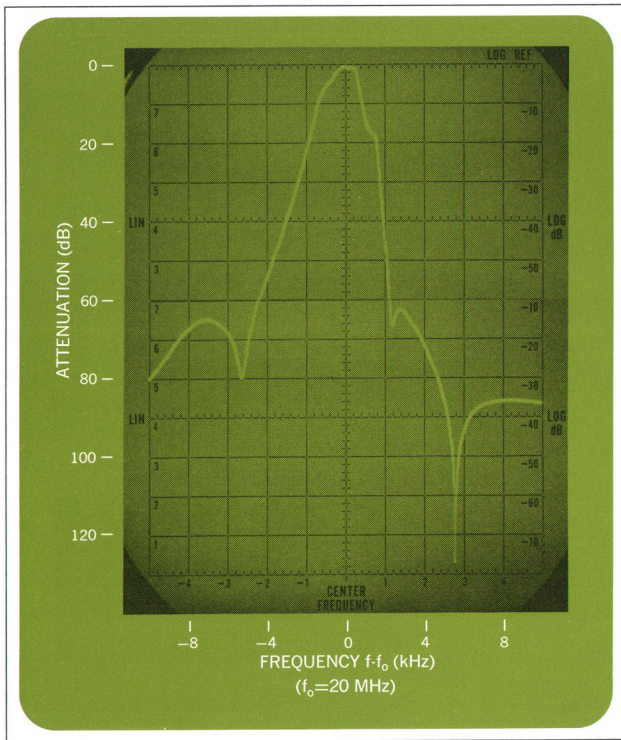

Fig. 2. Crystal filter response shows 60-dB bandwidth of 6.6 kHz, 80-dB bandwidth of 14.5 kHz, -127 dB zero 5.6 kHz above center frequency. Two photographs were taken for different analyzer gain settings, and were put together to show the complete response.

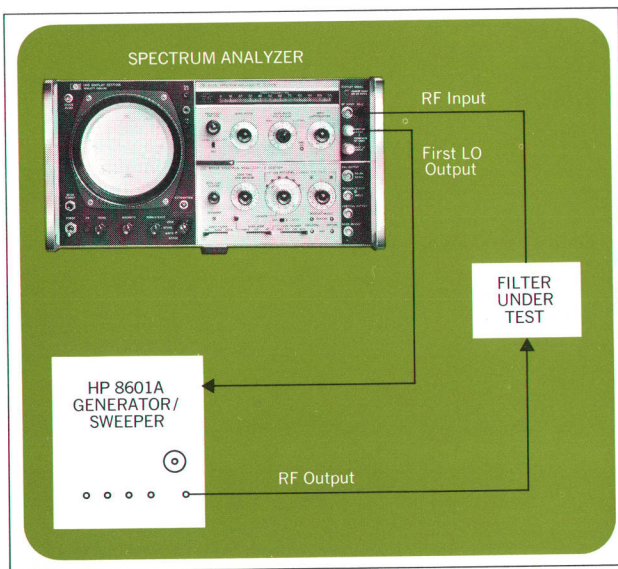

Fig. 3. Tracking generator for broadband displays, 500 kHz to 100 MHz wide, is a modified Model 8601A Generator/Sweeper.

absolutely calibrated in dBm, distortion can be measured as a function of signal level. The analyzer's 70-dB measuring range reveals distortion as low as 0.03%. The minimum discernible on an oscilloscope is usually about 5%.

Frequency Converters

Measurements on frequency converters such as mixers are best made in the frequency domain, since amplitude and frequency are the primary parameters for these devices. Fig. 3 illustrates an analysis of the output of a double balanced mixer which is being driven by an LO at 50 MHz and by an input signal at 5 MHz. The mixer has a conversion loss of 6 dB, LO isolation of 56 dB, and signal-to-output-port isolation of 35 dB. Third-harmonic distortion products in the output are 32 dB down. Notice in these measurements the importance of the analyzer's broad frequency range, calibrated amplitude and frequency scales, and flat frequency response. Flat response is especially important, for without it comparisons of signal levels at widely differing frequencies would be meaningless.

Modulators

Amplitude modulation indexes as low as 0.06%, much too low even to be seen on an oscilloscope, can be measured using the 70-dB display range of the new spectrum analyzer. Fig. 4 shows the spectrum of a 15-MHz signal amplitude-modulated at a 10-kHz rate. If β is the ratio of the carrier amplitude V_c to the sideband amplitude V_s , expressed in dB, then modulation index m is given by

$$m = 2 \times 10^{-\beta/20}$$

In Fig. 4, the sidebands are 40 dB below the carrier. Hence

$$m = 2 \times 10^{-40/20} = 0.02 = 2\%$$

If the sidebands are 70 dB down, $m = 2 \times 10^{-70/20} = 0.06\%$. Using the analyzer in the zero-scan mode (as a fixed-tuned variable-bandwidth receiver), the modulation envelope can be recovered at the VERTICAL OUTPUT connector. Modulation envelopes can also be displayed on the analyzer by using video triggering.

For frequency-modulated signals, modulation index and peak frequency deviation can be determined by the Bessel null technique. Frequency modulation can be recovered by using the skirts of the analyzer's IF filters as a discriminator when the analyzer is in the zero-scan mode.

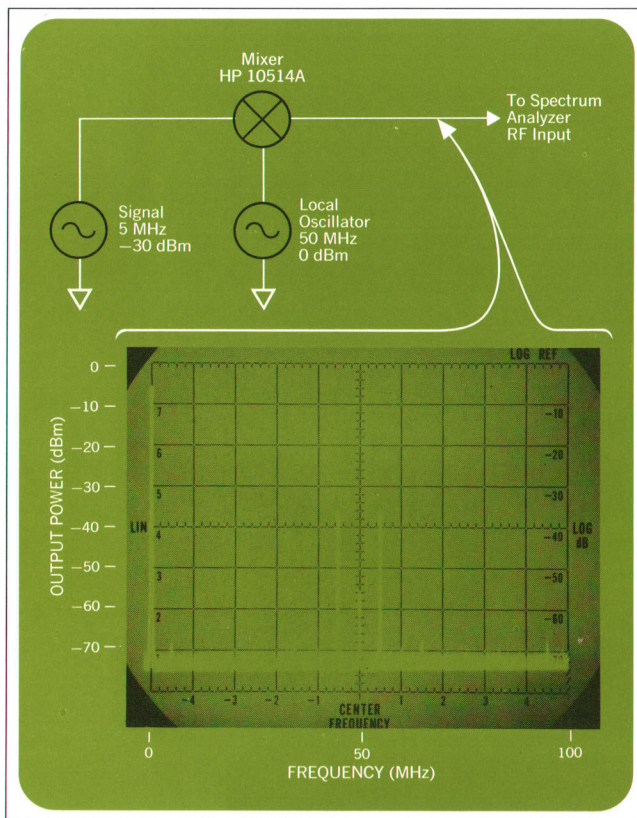

Fig. 3. This is the output spectrum of a double balanced mixer driven by an LO signal at 50 MHz and 0 dBm, and by an input signal at 5 MHz and -30 dBm. Sidebands at 45 and 55 MHz have 6 dB conversion loss (they are 6 dB below the -30 dBm graticule line). LO isolation is 56 dB (50-MHz signal in output is 56 dB below LO input level). Signal-to-output-port isolation is 35 dB (5-MHz signal leak is at -65 dBm, 35 dB below input level). Third-harmonic products at 35 and 65 MHz are 32 dB down.

There are numerous other spectrum measurements that can be made. For example, incidental FM on an AM signal can be observed and measured, and intermodulation distortion can be studied in mixers, amplifiers, and multiplex-telemetry and other systems.

Resolving Closely Spaced Signals

The resolution of a spectrum analyzer is its ability to separate closely spaced signals. This is important in measuring intermodulation distortion and low-frequency FM and AM, among other things. Resolution is determined mainly by the IF bandwidth. The new analyzer has nine IF bandwidths, ranging from 50 Hz to 300 kHz. Fig. 5 demonstrates the resolution of the 50-Hz IF filter, which has a 3-dB bandwidth of 50 Hz and a 60-dB band-

width of 1 kHz. This filter can resolve two signals which differ in amplitude by 40 dB when they are only 400 Hz apart.

Narrow filters are not the only factor determining the resolution of an analyzer. High stability is required of the internal oscillators in the analyzer, to prevent a grass-like, noisy display. An automatic stabilization system in the new analyzer phase-locks the first local oscillator to a stable reference for scan widths less than 500 kHz. This not only gives high resolution, but also makes it possible to check signal generators for residual FM or frequency drift, to measure phase noise in phase-lock systems, and to evaluate oscillator spectral purity.

Oscillators

Fig. 6 shows the warmup drift of a 20-MHz oscillator, displayed on the optional variable-persistence display section. Single scans were triggered every 5 seconds and the traces stored on the CRT. The display indicates a drift of about 600 Hz in 80 seconds.

Residual FM noise sidebands of an oscillator can also be evaluated. Fig. 7 shows the spectrum of a 100-MHz oscillator. The deviation at the top of the trace shows low-frequency residual FM of about 4 kHz peak-to-peak. The 'grass' at the edges of the trace indicates a sideband noise level about 65 dB below the carrier, 10 kHz away from the center frequency.

Sensitivity

Sensitivity is one of the most important characteristics of an analyzer. The new analyzer is sensitive enough to be used as a tuned RF voltmeter or power meter to measure levels as low as $0.07 \mu\text{V}$ (-130 dBm). Such sensitivity is needed in radio-frequency-interference and electronic-countermeasure surveillance. In these applications, the analyzer might well be used with a calibrated antenna to measure absolute field strengths.

The analyzer is most sensitive when it is used with the 50-Hz IF bandwidth and an X-Y recorder. Front-panel jacks on the analyzer supply vertical and horizontal signals to drive the recorder. Signals are easily discernible on the CRT at levels about 10 dB higher than the smallest signal that can be seen on the recorder trace.

Hardware

The new spectrum analyzer consists of a Model 8553L RF Section and a Model 8552A IF Section. Both of these are plug-ins for a display section, which can be any

of six versions. Model 140S Display Section has RF shielding and filtering for maximum analyzer sensitivity, and a special graticule which has LOG and VOLTAGE scales. This display section is adequate for most applications. Model 141S Display Section has the added advantage of variable persistence, which eliminates flicker when slow scan rates are used, and gives an improved display of closely spaced or transient signals. Model 143S Display Section has a large 8-by-10-inch display, which is especially useful for improved resolution, or when the analyzer is to be viewed from a distance or by several people at one time.

The RF and IF plug-ins can also be used with Model 140A, Model 141A, or Model 143A Oscilloscopes. However, susceptibility to conducted RFI will be greater and the graticules will not be labeled for spectrum analysis.* The 1400 series oscilloscope plug-ins that fit the 140A, 141A, and 143A Oscilloscopes will also work in the 140S, 141S, and 143S Display Sections.

* A clear overlay is available for calibrating these graticules.



Brian D. Unter

Brian Unter came to HP in 1965 from the University of Wisconsin where he received his BSEE (1964) and MSEE (1965). He first worked on the design of the 313A Tracking Oscillator and the preliminary design of the 8552A/8553L Spectrum Analyzer, including the mixers, filters, and 1st and 2nd IF amplifiers. He also worked on the spurious response problem. In 1967 he was appointed project

leader for the Spectrum Analyzer.

While at the University of Wisconsin Brian worked half time as an instructor and a researcher for Wisconsin's weather satellite program. He was elected to Tau Beta Pi and Eta Kappa Nu, and is currently a member of IEEE. He enjoys photography, ice skating, and woodworking.

Brian is continuing to work on projects related to spectrum analyzers and is presently leading the development effort on a tracking generator for the 8552A/8553L.

Fig. 4. Spectrum of a 15-MHz signal with 10-kHz amplitude modulation. Sidebands are 40 dB below the carrier, so modulation index m is $2 \times 10^{-40/20} = 0.02 = 2\%$. The 70-dB display range of the new spectrum analyzer can be used to measure modulation indexes as low as 0.06%. The analyzer can also be used as a fixed-tuned receiver to recover the modulation. **Fig. 5.** The new analyzer's 50-Hz IF bandwidth can resolve signals differing by 40 dB in amplitude when they are 400 Hz apart. There are eight other IF bandwidths. This is the spectrum of a carrier amplitude-modulated at 400 Hz, as seen with the 50-Hz bandwidth. Sidebands are 16 dB below the carrier, indicating a modulation index of 30%. Second-harmonic distortion products are more than 30 dB below the fundamental. **Fig. 6.** Warmup drift of a 20-MHz oscillator, displayed on the optional variable persistence display section. Single analyzer scans were triggered every 5 seconds and the traces were stored. The oscillator drifted about 600 Hz in 80 seconds. **Fig. 7.** Spectrum of a 100-MHz oscillator. The deviation at the top of the trace shows about 4 kHz residual FM. The 'grass' at the edges of the trace indicates a sideband noise level about 66 dB below the carrier, 10 kHz away from the carrier frequency.

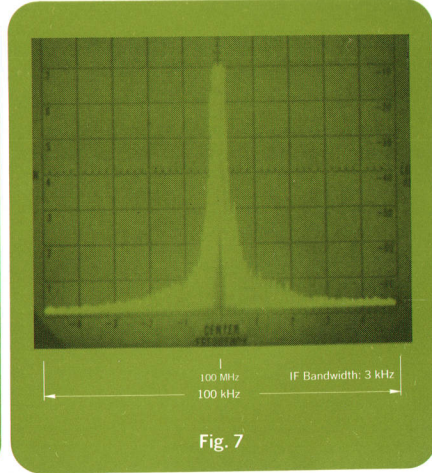
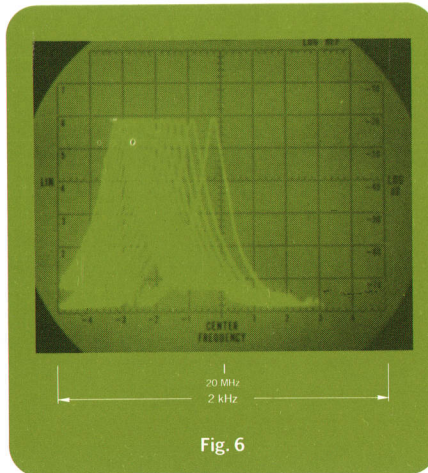
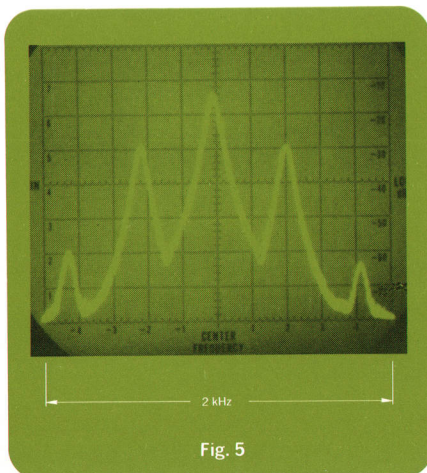
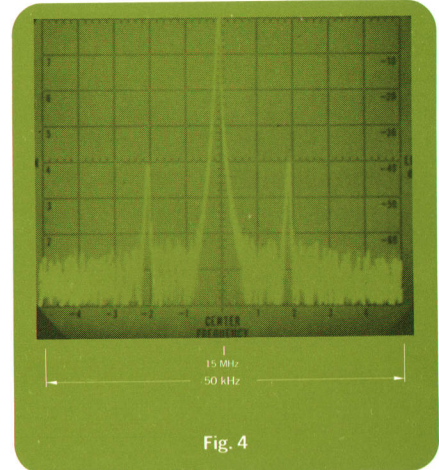

Design of a Third-Generation RF Spectrum Analyzer

Making a spectrum analyzer that is precisely calibrated and as easy to use as an oscilloscope required a number of new circuit and system techniques

By Thomas L. Grisell, Irving H. Hawley, Jr.,
Brian D. Unter, and Paul G. Winninghoff

THE FIRST SPECTRUM ANALYZERS were definitely not precision instruments. They were narrow-band, virtually uncalibrated spectrum viewers, good for qualitative work but not for analysis.

HP's microwave spectrum analyzer (Model 851B/8551B) was the first 'second generation' analyzer. This instrument has both amplitude and frequency calibration and wide-scan capability.

The new Model 8552A/8553L Spectrum Analyzer, whose capabilities are demonstrated in the preceding article, is a third generation analyzer, the first of its kind in the RF frequency range. It has precise, absolute, amplitude and frequency calibration, exceptional frequency stability, flat frequency response, no spurious responses, wide-scan capability, and a wide range of bandwidths. These characteristics and others make it as accurate and as easy to use as an oscilloscope, something that spectrum analyzers have never been before. But before this goal could be reached, several new system and circuit techniques had to be developed.

Basically a Swept Receiver

The spectrum analyzer is basically a swept receiver which has a CRT display. Fig. 1 is a simplified block diagram.

The sawtooth generator produces a ramp of voltage which is simultaneously applied to a voltage-tunable local oscillator and to the deflection plates of the CRT. The horizontal position of the dot on the screen is then proportional to frequency.

As the voltage-tunable local oscillator (LO) is swept across a frequency band, a signal at the input is converted to an intermediate frequency f_{IF} . The IF signal is detected, amplified, and applied to the vertical deflection plates. The resulting display is an amplitude-versus-frequency plot of the input signal.

Signals at the RF input are converted according to the basic mixing relationship:

$$f_{IF} = \pm(mf_{LO} \pm nf_{SIG}).$$

$$m \text{ and } n = 1, 2, 3, \dots$$

Filtering at the input and at the first IF rejects all har-

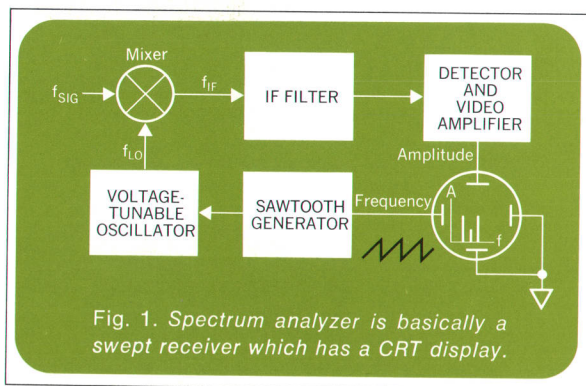

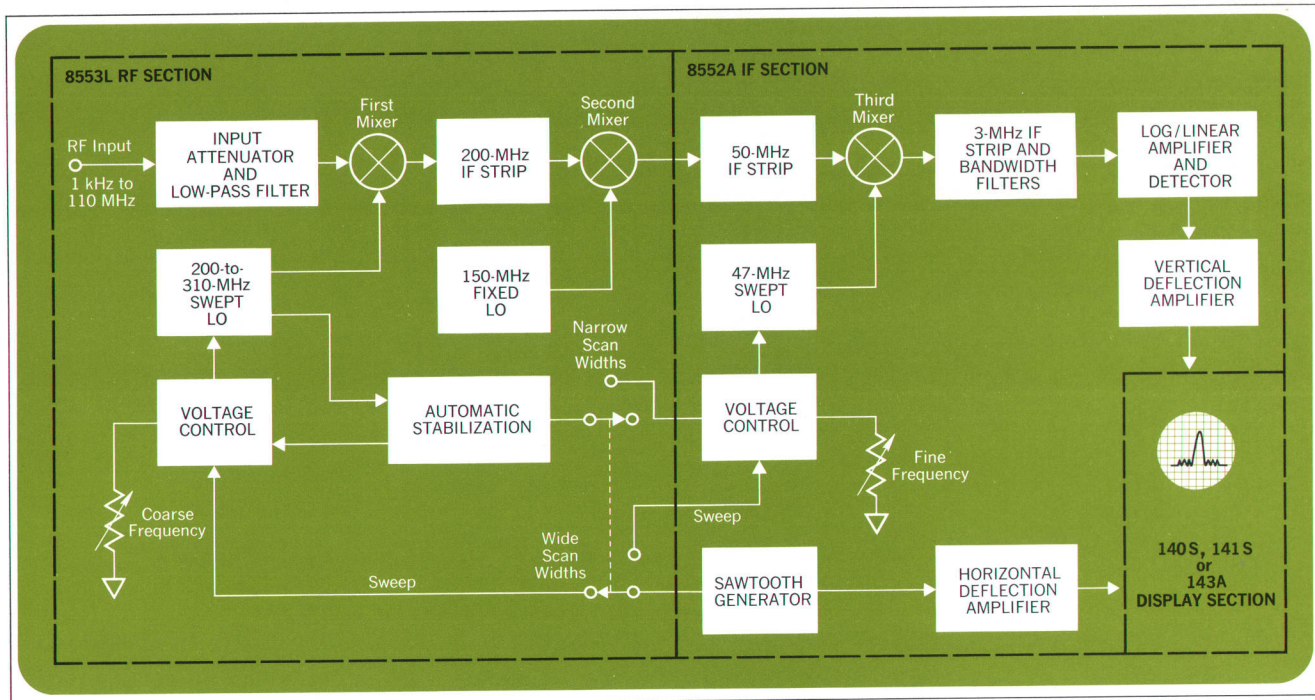

Fig. 2. New spectrum analyzer uses a triple conversion process. For wide scan widths, the first local oscillator is swept. For narrow scan widths, the third LO is swept and the first LO is phase-locked to a stable reference. The second LO is always fixed.

monic and image products and allows only the desired response

$$f_{IF} = f_{LO} - f_{SIG}$$

For example, a 50-MHz input signal will mix with a 250-MHz LO signal to produce the IF frequency of 200 MHz.

Notice that the analyzer converts the input signal upwards in frequency. Up-conversion of the input signal to the first IF greatly reduces the number of spurious mixing products. However, to physically realize narrow bandwidths, filtering must be done at a lower frequency. Therefore the analyzer uses a triple conversion process.

Triple Conversion Process

Fig. 2 is a detailed block diagram of the new spectrum analyzer. The instrument consists of a display section and two plug-ins, Model 8553L RF Section and Model 8552A IF Section. Signal flow in the diagram is along the top, from the RF plug-in to the IF plug-in to the display section.

A signal between 1 kHz and 110 MHz appearing at the RF input goes first through an input attenuator and a low-pass filter to the first mixer. The low-pass filter attenuates out-of-band signals and prevents the formation of undesired mixing products which would appear as spurious responses. At the first mixer the signal is up-converted by the local oscillator to 200 MHz. It then

goes through an IF amplifier and filter to the second mixer.

In the second mixer the signal is converted to 50 MHz by a crystal-controlled 150-MHz local oscillator. The 50-MHz IF signal goes to the IF plug-in, where it is again amplified and filtered. It then reaches the third mixer.

In the third mixer the signal is converted to 3 MHz by the 47-MHz local oscillator. The 3-MHz IF strip does the final IF filtering and amplifying. It has more than 100 dB of calibrated gain adjustment so that signals of widely varying amplitudes can be measured, and it has nine calibrated bandwidths for use with different scan widths.

Final signal processing is done in the log amplifier and detector. The signal is amplified logarithmically, or linearly in the linear display mode, and its amplitude is detected and displayed on the CRT.

Scanning and Phase-Lock System

High stability and ease of operation were the principal design requirements for the frequency-scan system. There are two local oscillators that can be swept. For scan widths between 10 MHz/div and 50 kHz/div, the 200-to-310-MHz first local oscillator is swept. For scan widths between 20 kHz/div and 0.2 kHz/div, the 47-MHz third local oscillator in the IF plug-in is swept. Sweeping the 47-MHz third LO for narrow scan widths makes it possible to get better stability by phase-locking the first LO to a very stable fixed-frequency reference.

The 200-to-310-MHz first local oscillator (VTO) is a voltage-variable-capacitor-tuned LC oscillator which has good stability and low phase noise (see Fig. 3). It consists of a pi tank circuit, a two-transistor oscillator which has

a phase shift of 180° (Q1 and Q2), and a grounded-base buffer amplifier (Q3). Good stability is achieved by using high-Q elements in the tank circuit and by keeping the loading of the tank circuit to a minimum. Power output is limited by the dc collector current in Q2, which serves both as an amplifier and as a limiter.

To take full advantage of the VTO's inherent good stability, noise and drift on the control voltage had to be minimized. This was done by using low-noise operational amplifiers for summing and shaping the control voltage. The shaping amplifier uses twelve straight-line segments to generate its nonlinear transfer characteristic and gives a voltage-to-frequency characteristic that is typically linear within $\pm 5\%$ or better, even for the narrowest scan widths.

The good stability and low phase noise of the 200-to-310-MHz first local oscillator system makes it possible to use IF bandwidths as narrow as 1 kHz without stabilizing or phase-locking the first LO. After warmup, drift is typically less than 10 kHz in 10 minutes and residual FM is less than 300 Hz peak-to-peak.

When the IF bandwidth becomes narrower than 1 kHz, the instability of the 200-to-310-MHz first local oscillator becomes apparent. An improvement in the analyzer's stability of better than an order of magnitude can be obtained by phase-locking the first LO to a harmonic of the 100-kHz reference. Phase-locking is accomplished simply by throwing a front panel switch from UNSTABILIZED to STABILIZED. No pre-stabilization adjustment or trace recentering is necessary.

When the analyzer is switched to STABILIZED, the APC line (Fig. 4) is disconnected from ground, allowing the APC loop to operate. The search network sweeps the VTO until the VTO's frequency reaches some harmonic of 100 kHz. At this point the VTO locks onto the harmonic of the 100-kHz reference and the APC loop becomes stable, disabling the search signal. An error voltage, V_e , which is proportional to how far the VTO frequency had to shift to reach a harmonic of the 100-kHz reference, is established on the APC line. This error voltage is applied to the 47-MHz LO in the IF plug-in. The 47-MHz LO then shifts its frequency the same amount that the VTO shifted to reach a phase-lock point. As a result, there is essentially no change in the location of a trace on the analyzer's screen when the analyzer is switched from UNSTABILIZED to STABILIZED.

The stabilization system operates only for narrow scan widths, when the 47-MHz local oscillator is swept so that

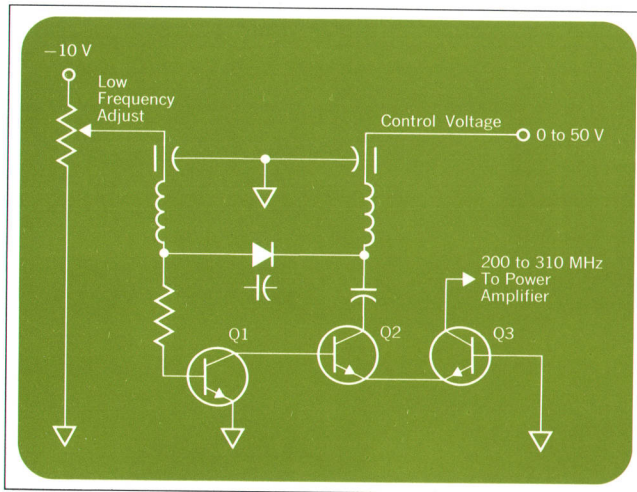

Fig. 3. Voltage-tunable first local oscillator operates between 200 MHz and 310 MHz, has good stability and low phase noise.

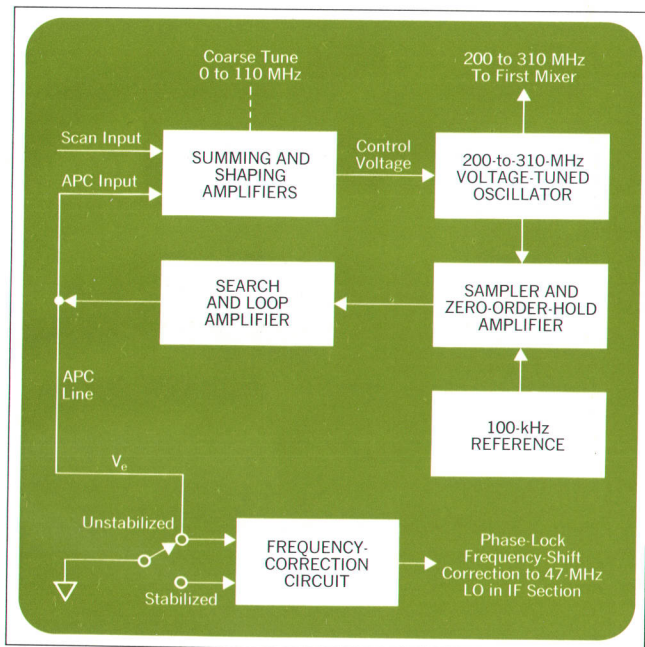

Fig. 4. When the APC loop is closed, the search network tunes the VTO until the VTO frequency is equal to a harmonic of 100 kHz. Then the loop locks and an error voltage, V_e , is sent to the 47-MHz third local oscillator, shifting its frequency the same amount that the VTO shifted to reach a lock point. Thus there is essentially no shift in the position of a trace on the CRT when stabilization is switched on.

the first local oscillator can become a fixed-tuned signal source. For scan widths wider than 20 kHz/div, that is, when the first local oscillator is swept, an override on the scan-width switch prevents any attempted phase-lock of the first LO, regardless of the tuning-stabilizer switch setting. Thus the stabilizer can be left on all the time, and the first local oscillator will automatically go into stabilization when the scan width is switched to 20 kHz/div or narrower. In this sense the stabilization system is fully automatic. The only caution an operator must observe is not to use the first local oscillator's coarse tune for scan widths narrower than 20 kHz/div with the stabilizer on and the first LO phase-locked. If this is done the first LO may jump its lock point to the next higher or next lower harmonic of 100 kHz. Tuning should be done instead with the fine-tune control, which tunes the 47-MHz local oscillator.

Eliminating Spurious Responses

A spectrum analyzer of the superheterodyne-receiver type is subject to numerous spurious responses. Normally the most troublesome to eliminate are the residual responses, which appear as false indications when no signal is present at the input. Residual responses result when the higher harmonics of internal oscillators mix together to produce signals at one of the intermediate frequencies.

In a broadband receiver the residual problem is compounded by the number of different local oscillators and intermediate frequencies. It is possible for each mixer to have high output levels through the tenth harmonic of each oscillator. In a triple conversion spectrum analyzer all of the harmonics of the three LO's can mix with each other to produce any of the three intermediate frequencies.

To help identify residual responses and locate their sources, a computer program was written. The program applies the general mixing equation to each converter and calculates the frequencies where spurious responses will occur. The harmonic numbers and frequencies involved are also printed, so that filter requirements can be determined.

The computer printout for the interaction of the first and second local oscillators is shown in Fig. 5.

Spurious responses are printed out in the order of

8553L-8552A RESIDUAL SPURIOUS RESPONSES				
FIRST MIXER				
1ST LO	2ND LO	1ST LO MHZ	2ND LO MHZ	SPUR MHZ
1	3	250	450	50
2	2	500	300	50
2	4	400	600	0
2	5	550	750	75
3	3	650	450	16.6667
3	4	800	600	66.6667
3	6	700	900	33.3333
3	7	850	1050	83.3333

Fig. 5. The new spectrum analyzer's residual responses are typically much lower than -110 dBm. To get them this low, a computer program was written to identify residual responses (SPUR) so that filters could be designed to suppress them. This is the printout for the first mixer.

ascending harmonic numbers of the LO's. This corresponds approximately to the order of importance of the responses, since higher harmonic conversions are generally at lower levels. The first line in the table indicates that a residual response (SPUR) will occur at 50 MHz on the spectrum-analyzer frequency dial if the first and second LO frequencies of 250 MHz and 450 MHz are allowed to mix. These frequencies correspond to the fundamental and third harmonic of the first and second LO's, respectively. These signals are suppressed in the analyzer through careful filter and mixer design.

As a result of this computer-aided design technique, the new spectrum analyzer has virtually no residual responses. These responses are typically much less than -110 dBm. This is one reason for the analyzer's 70-dB clutter-free display range.

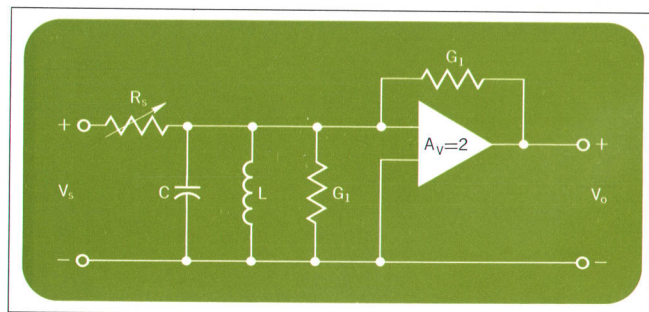

Fig. 6. LC filters are used for the 100 kHz, 30 kHz, and 10 kHz IF bandwidths. Feedback amplifier cancels tank circuit losses represented by G_1 to make gain nearly independent of bandwidth.

3-MHz IF Has Several Bandwidths

The new spectrum analyzer has nine calibrated bandwidths. They are determined by a series of gain-compensated variable-bandwidth LC and crystal filters in the 3-MHz IF strip. Bandwidth selection is controlled by diode switches and relays, which are programmed by the BANDWIDTH switch in the RF plug-in. Essentially constant gain (typically within ± 0.2 dB) for all band-

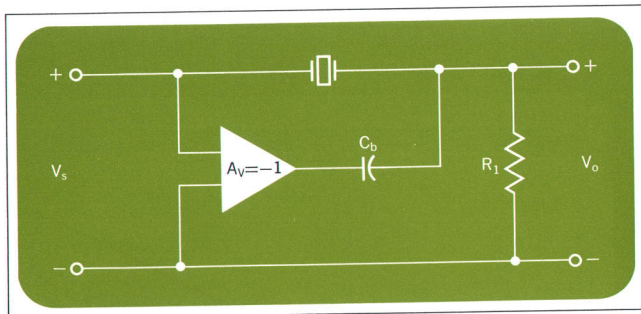

Fig. 7. Crystal filters are used for the 3 kHz, 1 kHz, 300 Hz, 100 Hz, and 50 Hz IF bandwidths. Amplifier balances shunt capacitance of crystal.

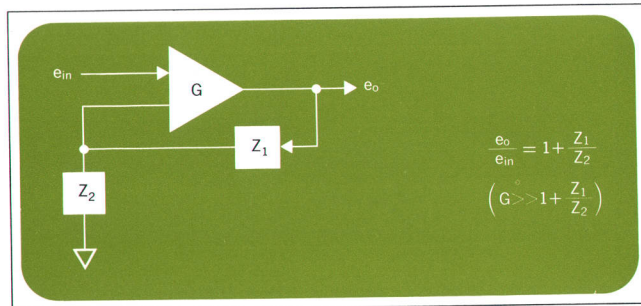

Fig. 8. This is the type of amplifier used for gain adjustment in the 3 MHz IF strip. Gain is adjusted by varying Z_1 and Z_2 . Gain can be varied in 10-dB steps over a 90-dB range and continuously over a 12-dB range.

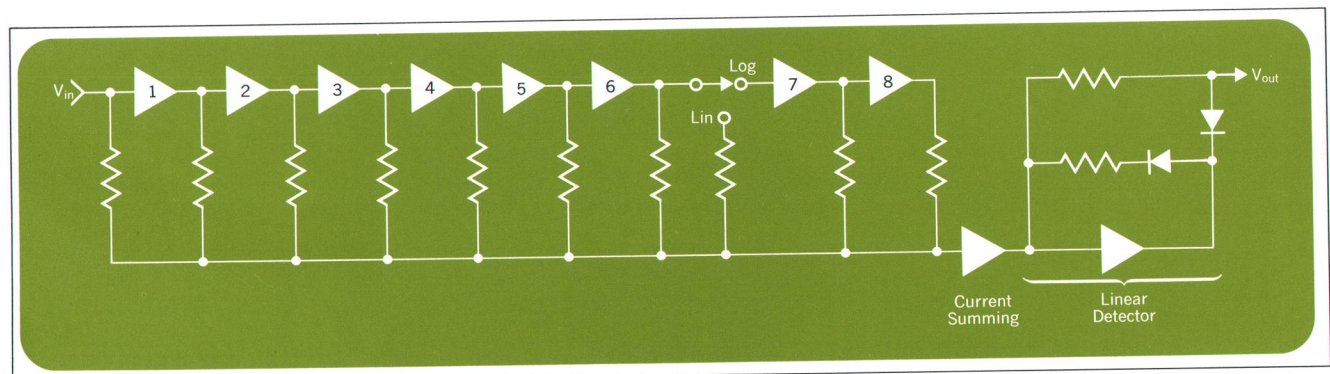

Fig. 9. Logarithmic amplifier has 70-dB dynamic range and is typically accurate within ± 0.3 dB. It can also operate in a linear mode.

widths was a design requirement, so that the analyzer could be absolutely calibrated.

The widest bandwidth, 300 kHz, is determined by a fixed LC filter at the beginning of the 3-MHz IF strip. LC filters are also used for the 100-kHz, 30-kHz and 10-kHz bandwidths. Fig. 6 shows a typical LC filter stage. Feedback is used to cancel losses in the LC tank circuit and make it appear ideal. The rest of the circuit presents a negative input impedance to the tank circuit and cancels the losses, which are represented by G_1 in Fig. 6. Bandwidth is controlled by varying the source resistance, R_s . Since the tank circuit appears ideal, there is no voltage drop across R_s at resonance. Hence the gain at resonance is independent of bandwidth.

In the crystal filters, very-high-Q crystals and low-output-impedance amplifiers make the gain at resonance independent of bandwidth. Fig. 7 shows one of the three similar stages. V_s represents the output voltage of a feedback amplifier which has an output impedance of approximately one ohm. The voltage amplifier with a gain of -1 balances out the shunt capacitance of the crystal. Bandwidth is varied by changing R_1 . Overall bandwidth for the three stages of crystal filters varies from 3 kHz to 0.05 kHz. Gain at resonance remains essentially constant since V_s comes from a low-impedance source and the crystal is nearly lossless. As R_1 becomes very small (100Ω) some compensation for crystal losses is made in an amplifier stage.

The gain of the 3MHz IF strip is controlled over a 90-dB range in 10-dB steps by diode-switched variable-gain amplifiers. Continuous gain variation over a 12-dB range is provided by voltage-variable-capacitors (diodes) in the fine-gain amplifier. Fig. 8 shows the type of amplifier used. Z_1 and Z_2 are switched in steps for the switched-gain amplifiers and are varied continuously for the fine-gain amplifier.

70-dB Log Amplifier

The logarithmic amplifier, Fig. 9, uses a successive limiting technique to achieve wide bandwidth and a 70-dB dynamic range. This amplifier has eight amplifier/limiter stages, each of which has 9 dB of gain. The logarithmic characteristic is obtained by summing the outputs of the individual stages.

To understand the operation of the log amplifier, first consider a weak signal, one just strong enough so that the eighth stage begins to limit. The output voltage of each stage is limited to approximately three volts. When the eighth stage begins to limit, the output of the log amplifier is a voltage proportional to the output of the eighth stage, plus a voltage proportional to the sum of the outputs of the first seven stages, which have not yet limited. Thus the output is $K(3 + S_7)$ volts, where K is a constant gain factor. If the input signal increases by 9 dB, the seventh stage begins to limit, and the output is a voltage proportional to the sum of the outputs of two limiting stages, plus a voltage proportional to the sum of the outputs of six non-limiting stages. Thus the output is $K(6 + S_6)$. If the input increases another 9 dB, the output is $K(9 + S_5)$, and so on.

Now by summing part of the input signal with the output of each amplifier/limiter stage, all of the sums S_7, S_6, S_5 , and so on, are made equal. Thus $S_7 = S_6 = S_5 = \dots = S$. Consequently, the points where the successive stages begin to limit fall on a line whose equation is

$$V_{out} = K \left[\frac{3 \left(20 \log_{10} \frac{V_{in}}{V_r} \right) dB}{9 dB} + S \right]$$

where V_r and K are constants. This is a logarithmic amplifier characteristic. Between the points where the successive stages begin to limit, the amplifier's output approximates this characteristic closely. The amplifier's characteristic is logarithmic typically within ± 0.3 dB over the full 70-dB range.

For a linear display, the amplifier is made to operate in a linear mode by increasing the weighting of the output of the sixth stage so that none of the stages limit, even when the output reaches its maximum value. The last two stages are switched out in the linear mode; this maintains the same output signal-to-noise ratio in the linear mode as in the log mode.

Other Systems Considerations

Although it is impossible to give details here, a large part of the design time on this project was spent on systems considerations that are often taken for granted. These are such things as temperature sensitivity, suscep-



Thomas L. Grisell (left) designed the 3-MHz amplifiers and IF filters for the 8552A/8553L Spectrum Analyzer, then assumed responsibility for the technical aspects of the 8552A IF Section in the final design phase. He came to HP in 1965 and helped design the 312A Wave Analyzer before switching to spectrum analysis.

Tom received his BS degree in electrical engineering from San Jose State College in 1965. In June 1968 he will receive his MSEE degree at Stanford, where he is enrolled in the HP Honors Cooperative Program. Tom is a member of IEEE. Among his interests are music, amateur radio, high-fidelity sound reproduction, and tennis.

Irving H. Hawley, Jr. (center), currently the production engineer for the 8552A/8553L Spectrum Analyzer, designed the analyzer's local oscillators and phase-lock stabilization system. He has a patent pending on the phase-lock system. His previous projects include an investigation of the variable-bandwidth crystal filters in the 302A Wave Analyzer, preliminary design of the counter in the 312A Wave Analyzer, and design of the first prototype of the 313A Tracking Generator.

Irv graduated from Harvey Mudd College in 1964 with a BS degree in engineering. He received his MSEE degree from Stanford University in 1967. He joined HP in 1964.

Paul G. Winninghoff (right) designed the logarithmic amplifier and the deflection circuits for the 8552A/8553L Spectrum Analyzer. This was his first project for HP. Before he came to HP in 1964, Paul worked a year as a research associate at Montana State College, investigating narrow-band constant-time-delay IF amplifiers.

Paul received his BS and MS degrees in electrical engineering from Montana State College in 1962 and 1963. He was elected to Tau Beta Pi and Phi Kappa Phi. His hobby is amateur radio.

tibility to vibration and shock, and electromagnetic compatibility. Stability and reliability were important design requirements from the beginning of the project, so the completed system would require a minimum of servicing.

Acknowledgments

It is a pleasure to recognize the contributions of the other members of the design team for the 8552A/8553L

Spectrum Analyzer. Philip B. Spohn directed the investigation and initial design stages. Design of the analogic circuitry was done by Patrick J. Barrett. Fred H. Meyers and John E. Nidecker did the product design, and S. Jack Magri was responsible for the overall industrial design.

We also wish to thank Paul C. Ely, Jr., Roderick Carlson, and Harley L. Halverson for their encouragement and helpful suggestions during the project.

PARTIAL SPECIFICATIONS

HP MODEL 8552A/8553L SPECTRUM ANALYZER

RF and IF Sections Specifications RF Input and Tuning Characteristics

FREQUENCY RANGE: 1 kHz to 110 MHz.

FREQUENCY RESPONSE: ± 0.5 dB, 1 kHz to 110 MHz (for attenuator settings ≥ 10 dB). Typical fine grain flatness, $\leq \pm 0.1$ dB per MHz.

INPUT IMPEDANCE: 50 Ω nominal.

MAXIMUM INPUT LEVEL: Peak or average power to input mixer $< +13$ dBm (1.4 Vac peak; ± 0.2 Vdc).

SENSITIVITY: $\frac{\text{Signal Power} + \text{Noise Power}}{\text{Noise Power}} = 2$

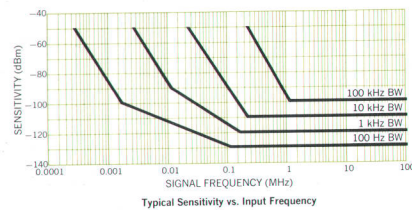

Typical Sensitivity vs. Input Frequency

TUNING DIAL ACCURACY: Display center frequency is within ± 1 MHz of indicated dial frequency.

CENTER FREQUENCY IDENTIFIER: Marker in 0 to 100 MHz SCAN WIDTH mode identifies display center frequency of SCAN WIDTH PER DIVISION and ZERO SCAN modes.

Scan Characteristics

SCAN WIDTH: 15 calibrated scan widths from 200 Hz/div to 10 MHz/div in a 1, 2, 5, 10 sequence plus ZERO and preset 0 to 100 MHz SCAN.

SCAN TIME: 16 rates from 0.1 ms/div to 10 s/div in a 1, 2, 5, 10 sequence, INTERNAL and SINGLE SCAN modes only.

SCAN MODE:
INTERNAL: Analyzer repetitively scanned by internally generated ramp; synchronization selected by SCAN TRIGGER, SCANNING lamp indicates duration of scan.
SINGLE: Single scan actuated by front panel pushbutton. SCANNING lamp indicates duration of scan.
EXTERNAL: Scan determined by 0 to +8 volt external signal; analyzer input impedance > 10 k Ω . Blanking: -1.5 V external blanking signal required.

SCAN TRIGGER: Required only when INTERNAL SCAN MODE selected.
AUTO: Scan free runs.
LINE: Scan synchronized with power line frequency.

EXTERNAL: Scan synchronized with external 2-to-20-volt signal (polarity selected by internally located switch of Model 8552A IF Section).

VIDEO: Scan internally synchronized to envelope of RF input signal (signal amplitude of 1.5 major divisions peak-to-peak required on display section CRT).

Spectral Resolution

IF BANDWIDTH: 3 dB bandwidths of 50, 100, 300 Hz, and 1, 3, 10, 30, 100 and 300 kHz can be selected.

IF BANDWIDTH SELECTIVITY: 60 dB/3 dB bandwidth ratio less than 20:1 for IF bandwidths from 1 kHz to 300 kHz. 60 dB/3 dB bandwidth ratio less than 25:1 for IF bandwidths from 50 Hz to 300 Hz.

VIDEO FILTER BANDWIDTH: Two post-detection bandwidths: 10 kHz and 100 Hz.

Amplitude Characteristics

VERTICAL DISPLAY CALIBRATION (8 divisions full scale deflection):

LOGARITHMIC: Calibrated directly in dBm over 140 dB range from -130 dBm to +10 dBm, 10 dB/div on 0 to -70 dB CRT display. LOG REFERENCE LEVEL control and log reference vernier establish absolute power reference level in dBm for CRT display.

LINEAR: Calibrated directly in V/div from 0.1 μ V/div to 100 mV/div in a 1, 2, 10 sequence. LINEAR SENSITIVITY and vernier controls establish absolute voltage calibration (deflection factor).

CALIBRATOR: 30 MHz signal provided as operating standard for absolute vertical calibration of display: -30 dBm ± 0.3 dB.

DISPLAY UNCALIBRATED LIGHT: Panel lamp warns operator of uncalibrated amplitude display if selected IF bandwidth or video bandwidth is too narrow for combination of scan width and scan time selected.

VERTICAL DISPLAY ACCURACY:

	LOGARITHMIC dBm	LINEAR volts
Calibrator	± 0.3 dB	$\pm 3.5\%$
Log Reference Level (Linear Sensitivity)	± 0.2 dB	$\pm 2.3\%$
Log Reference Vernier (Linear Sensitivity Vernier)	± 0.1 dB*	$\pm 1.2\%*$
RF Input Attenuator Accuracy (excluding flatness)	± 0.2 dB	$\pm 2.3\%$
Analyzer Frequency Response (flatness)	± 0.5 dB	$\pm 5.8\%$
Switching between Bandwidths (at 20°C)	± 0.3 dB	$\pm 3.5\%$
Amplitude Stability: 100 Hz - 300 kHz bandwidth	± 0.05 dB/°C	$\pm 0.6\%/^{\circ}\text{C}$
50 Hz bandwidth	± 0.1 dB/°C	$\pm 1.2\%/^{\circ}\text{C}$
CRT Display	± 0.25 dB/dB but not more than ± 1.5 dB over the full 70 dB display range.	$\pm 2.8\%$ of full 8 div deflection.

* Vernier accuracy at 0, 6, and 12 dB; otherwise ± 0.25 dB ($\pm 2.8\%$).

Spectral Purity

AUTOMATIC STABILIZATION: First local oscillator automatically stabilized (phase-locked) to internal reference for scans of 20 kHz/div or less.

RESIDUAL FM:

STABILIZED: Less than 20 Hz peak-to-peak.
UNSTABILIZED: Less than 1 kHz peak-to-peak.

NOISE SIDEBANDS: More than 70 dB below CW signal 50 kHz or more away from signal, with a 1 kHz IF BANDWIDTH setting.

SPURIOUS RESPONSES: For -40 dBm signal level to input mixer: image responses, out-of-band mixing responses, harmonic and intermodulation distortion products, and IF feedthrough responses all more than 70 dB below the input signal level.

RESIDUAL RESPONSES: 200 kHz to 110 MHz: < -110 dBm.
20 kHz to 200 kHz: < -95 dBm.

Display Section Specifications

Model 140S Specifications

PLUG-INS: Accepts Model 8552A/8553L Spectrum Analyzer plug-ins and Model 1400-series time domain plug-ins.

CATHODE-RAY TUBE:

TYPE: Post-accelerator, 7300 volt accelerating potential; etched safety glass face plate reduces glare; transparent coating reduces RFI. P7, medium-short persistence phosphor; light blue filter supplied.

GRATICULE: 8 x 10 divisions (approximately 7.2 x 9.0 cm) parallax-free internal graticule; five subdivisions per major division on horizontal and vertical axes.

Model 141S Specifications

PLUG-INS: Same as 140S.

CATHODE-RAY TUBE:

TYPE: Post accelerator storage tube, 7300 volt accelerating potential; aluminumized P31 phosphor; etched safety glass face plate reduces glare.

GRATICULE: 8 x 10 divisions (approximately 6.6 x 8.2 cm) parallax-free internal graticule; five subdivisions per major division on horizontal and vertical axes.

PERSISTENCE:

NORMAL: Natural persistence of P31 phosphor (approximately 0.1 second).

VARIABLE: Continuously variable from less than 0.2 second to more than one minute.

ERASE: Manual; erasure takes approximately 100 ms.
STORAGE TIME: To 1 hour.

Model 143A Specifications

PLUG-INS: Same as 140S. Plug-in panel nomenclature of centimeter divisions translates directly to inch divisions on the Model 143A display. For example, 5 V/cm sensitivity is displayed as 5 V/inch on the Model 143A.

CATHODE-RAY TUBE:

TYPE: Post-accelerator, 20 kV accelerating potential; aluminumized P31 phosphor (other phosphors available on order).
GRATICULE: 8 inch by 10 inch parallax-free internal graticule marked in one inch squares; major vertical and horizontal axes have 0.2 inch subdivisions (other graticules available on order).

General Specifications

CRT BASELINE CLIPPER: Front panel control adjusts blanking of CRT trace baseline to allow more detailed analysis of low-repetition-rate signals and improved photographic records to be made.

VERTICAL DISPLAY OUTPUT: Approximately 0 to -0.8 V for 8 div deflection on CRT; 2 k Ω output impedance.

SCAN OUTPUT: Approximately -5 to +5 volts for 10 div CRT deflection; 5 k Ω output impedance.

RFI: Conducted and radiated leakage limits are below requirements of MIL-I-16910C and MIL-I-6181D when 8553L and 8552A are combined in a 140S Display Section.

TEMPERATURE RANGE: Operating, 0° to +55°C; storage -40° to +75°C.

POWER REQUIREMENTS: 115 or 230 volts $\pm 10\%$, 50 to 60 Hz, normally less than 225 watts (varies with plug-in units used).

DIMENSIONS: 9 $\frac{1}{4}$ in high (including height of feet) x 16 $\frac{1}{2}$ in wide x 18 $\frac{3}{4}$ in deep (229 x 425 x 467 mm).

PRICE: Model 8552A IF Section, \$1,900.00.

Model 8553L RF Section, \$1,800.00.

Model 140S Display Section, \$725.00.

Model 141S Variable Persistence Display Section, \$1,525.00.

Model 143A Oscilloscope Main Frame, \$1,400.00.

MANUFACTURING DIVISION: MICROWAVE DIVISION
1501 Page Mill Road
Palo Alto, California 94304

New Concepts in Signal Generation

An AM/FM signal generator and precision sweeper in a single 21-pound package? Yes, thanks to thin-film microcircuits and AFC.

By John R. Hearn and Douglas C. Spreng

CHOOSING A SIGNAL SOURCE, whether for the laboratory or for the production line, has always involved a trade-off. There are manually tuned signal generators, which offer stability, low noise, and accurately calibrated controls, and there are sweepers, which can sweep broad frequency ranges quickly, but are much less stable and accurate.

New technology in the form of wideband thin-film amplifiers, and a new sweeper design concept incorporating automatic frequency control, have now generated a third alternative. HP Model 8601A, a new signal source for the frequency range 0.1 to 110 MHz, is called a 'generator/sweeper' because it has stability and accuracy comparable to those of signal generators, but is actually a sweeper. Its power output can be set anywhere between +20 dBm and -110 dBm, accurately within ± 1 dB below +13 dBm. Its output is flat within ± 0.25 dB over its frequency range, and it has low residual FM. It can also sweep more than two decades, and its voltage-to-frequency characteristic is linear within $\pm 0.5\%$.

Thin-Film Amplifiers Result In:

1. Smaller Size—Thin-film techniques have reduced the size and weight of the instrument drastically, not only by reducing component sizes, but also by providing natural heat sinking. Large heat sinks and fans have been eliminated. The generator/sweeper weighs only 21 pounds and fits in half the width of a standard rack (see Fig. 1); these are significant improvements in size and weight over older signal generators and low-frequency sweepers. To maintain controllability and ease of use despite the small front panel, an effort has been made to simplify the controls and to group them logically.

2. Reduced Harmonics and Spurious Signals—Fig. 2 is a block diagram of the generator/sweeper. The instrument's broad bandwidth is achieved by a heterodyne technique. A voltage-tuned oscillator produces an output between 200.1 MHz and 310 MHz, and this is mixed with the output of a stable 200-MHz oscillator to obtain a difference frequency of 0.1 to 110 MHz. The complete frequency range is covered in two overlapping ranges, 0.1 to 11 MHz and 1 to 110 MHz, giving a choice of expanded resolution at low frequencies while retaining wide frequency coverage on a single band.

Heterodyne signal sources aren't new. However, they normally have many shortcomings, notably spurious mixing products and high harmonics. They also usually have poor frequency accuracy, high drift rate, and large residual FM; these are consequences of translating the instabilities and inaccuracies of a high-frequency oscillator to lower frequencies. Lack of flatness and poor output accuracy are other typical problems, and many other more subtle degradations can occur. Because of all these problems, a heterodyne signal source can normally command little confidence in its front-panel settings and in the corresponding readouts and displays.



Fig. 1. Model 8601A Generator/Sweeper has accuracy and stability like those of signal generators, but is actually a sweeper. It fits into a 21-pound half-rack-width package, mainly because its output amplifier is a thin-film microcircuit. Its frequency range is 0.1 to 110 MHz.

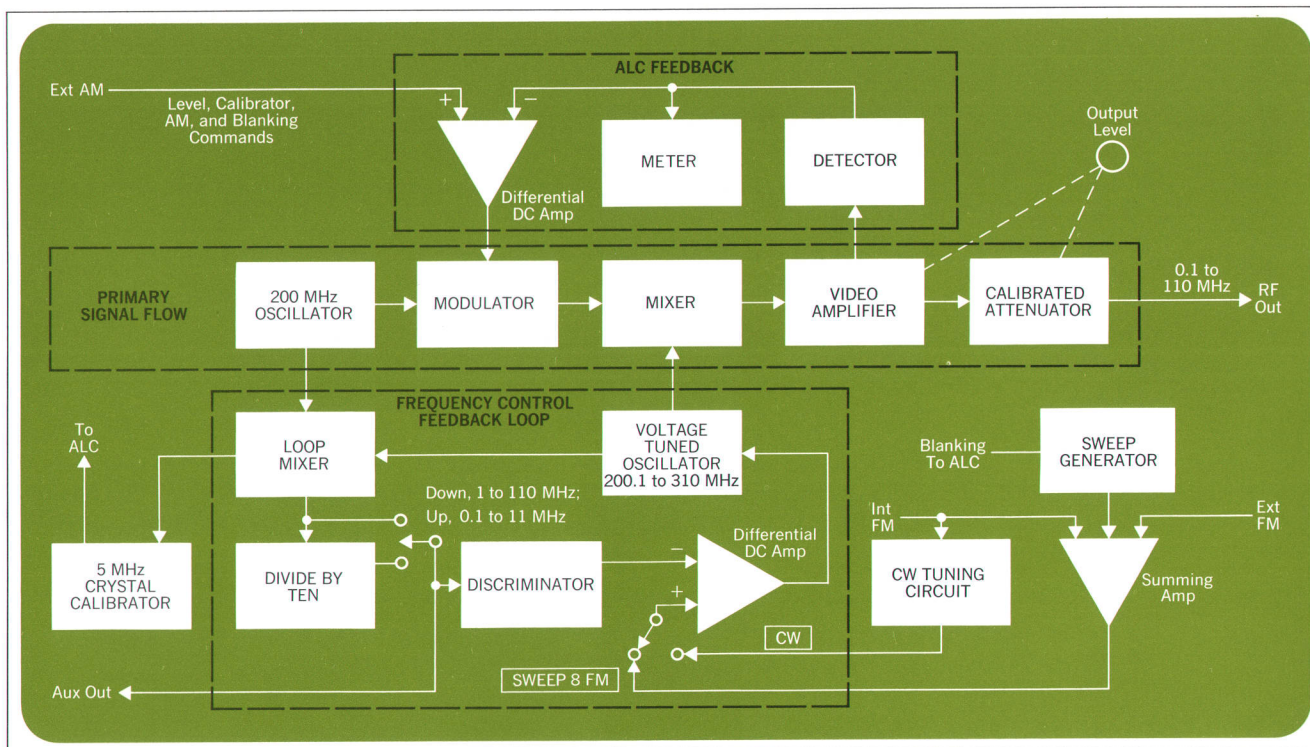

Fig. 2. The generator/sweeper is a heterodyne signal generator which has level-control and frequency-control feedback loops. The ALC loop holds the output power constant within ± 0.25 dB. The AFC loop gives high stability, 0.5% linearity, and 1% accuracy.

This is not the case, however, with the new generator/sweeper, because it has automatic level and frequency control loops to maintain its stability and accuracy. A key element in its performance is the thin-film video amplifier which follows the main mixer.

The video amplifier is a hybrid microcircuit. It is made by depositing thin-film elements on a sapphire substrate and bonding transistor chips to the film (Fig. 3). This technique eliminates the parasitic elements associated with long leads and provides excellent heat sinking.

As a result of good heat sinking and low parasitic capacitance, the video amplifier can operate at a high power level and still have low harmonic content. Amplifier power output is +10 dBm except at the highest output attenuator setting, where it is +20 dBm. At an amplifier output of +10 dBm, harmonics are more than 35 dB below the fundamental output, quite low for an instrument of this type. One consequence of the high power output is that even very lossy devices can be tested with ordinary detection systems.

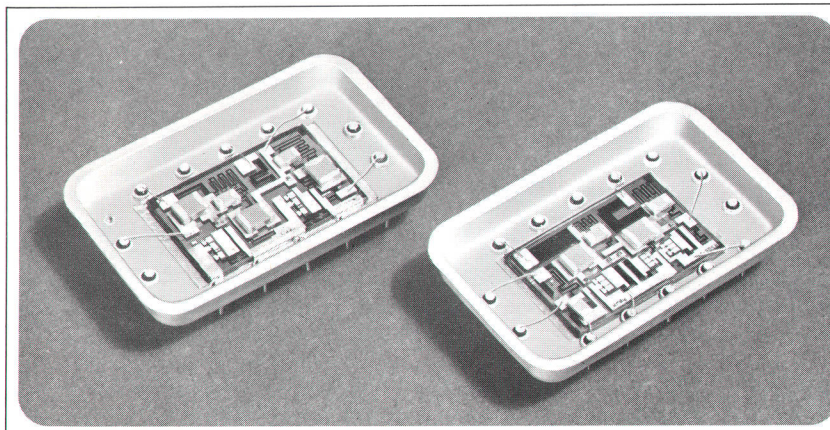

Fig. 3. Thin-film hybrid-microcircuit preamplifier (l) and power amplifier (r) are made by depositing thin-film elements on a sapphire substrate and bonding transistor and diode chips to the film. Parasitics are low and heat sinking is excellent. Each unit is 1.4 inches long.

The gain of the video amplifier is approximately 55 dB. Hence mixing takes place at a rather low level, so spurious signals are also low. Spurious signals in the output are more than 40 dB below the fundamental output. The high-gain amplifier also provides good isolation, which eliminates frequency pulling when the output level is changed. Negligible incidental FM is another benefit.

3. Improved Flatness and Accuracy — The automatic level control loop (see Fig. 2 again) is responsible for maintaining the generator/sweeper's flatness and output accuracy. Again, the thin-film video amplifier is the chief reason for the good performance of this loop.

As Fig. 4 shows, the video amplifier consists of a preamplifier followed by a power amplifier, a thin-film diode detector, and a 50 Ω thin-film resistor. The detector output is compared with a reference signal in a differential amplifier, which in turn controls a modulator to adjust the level of the 200-MHz signal coming into the main mixer.

The ALC loop is very similar in concept to voltage-control loops used at dc, for example in power supplies. As in dc loops, the diode detector for the ALC loop is located right at the output of the power amplifier. Open-loop gain is high, so the amplifier looks very much like an ideal voltage source, that is, a zero-impedance source. To give the instrument the required 50 Ω output impedance, the 50 Ω thin-film resistive strip is added.

Thin-film technology affects the design and performance of this loop in two ways. First, parasitic capacitance and inductance are small, so the thin-film amplifier's frequency response rolls off very little up to 110 MHz. Second, because of the excellent thermal conductivity of the sapphire substrate, the transistor chips can be run at higher-than-normal collector currents. Hence they have better high-frequency performance than they would if they were in cans mounted on a printed-circuit board.

For these two reasons, the amplifier has good frequency response before leveling, and high power output. High power is necessary to the design, since half the amplifier's output power is dissipated in the 50 Ω thin-film resistor.

The detector diode sees an RF signal that is twice the amplitude of the output signal after the 50 Ω resistor. Therefore the diode operates at high power, in its linear region. Hence both internal and external amplitude modulation experience less distortion than they would in a lower-power system, in which the detector would probably have to be operated in its square-law region.

Since the amplifier appears to have zero impedance, the source impedance seen by a load is just the impedance of the 50 Ω thin-film resistive strip. Consequently the source impedance doesn't vary with load changes or output attenuator settings. Source impedance is also constant with frequency. The thin-film resistor has very little parasitic inductance and still looks like a resistor at 110 MHz.

The ALC loop holds the power output of the generator/sweeper constant within ± 0.25 dB over the entire two decades on each of the instrument's two bands. There is no need for external leveling, and the output meter and attenuator are accurate at all frequencies. Hence most devices can be tested with assurance that what is being measured is the true frequency response of the device, and that the signal source is not contributing large variations of its own.

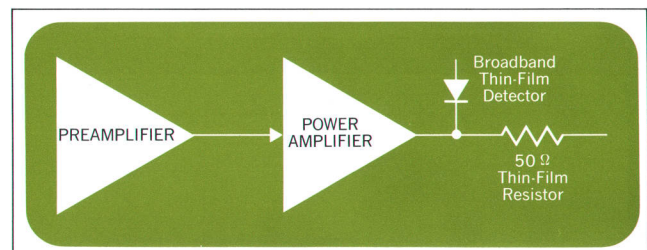

Fig. 4. Microcircuit output amplifier consists of a preamplifier, a power amplifier, a detector for the ALC loop, and an output resistor. The detector operates at high power, in its linear region. The high-gain ALC loop gives the power amplifier near-zero output impedance, so the instrument's output impedance is a constant 50 Ω .

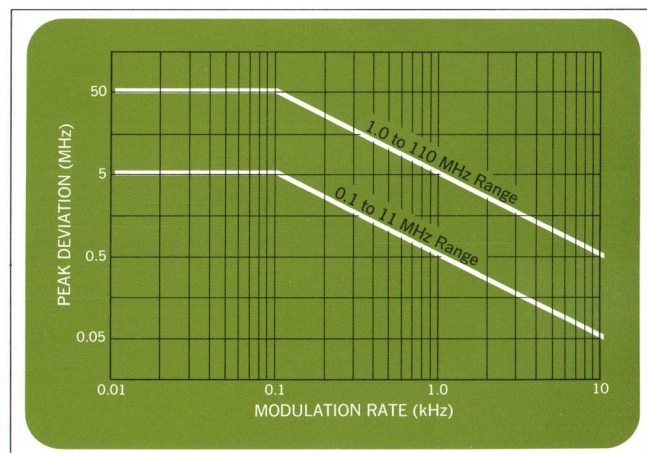

Fig. 5. Typical measured curves for 1% distortion of external FM. Generator/sweeper introduces less than 1% distortion as long as FM rate and deviation are below solid line (except that for peak deviations below bottom of graph, distortion begins to increase because of noise).

The front-panel meter reads the output of the thin-film ALC detector and therefore measures the true output level of the instrument and not some voltage reference.

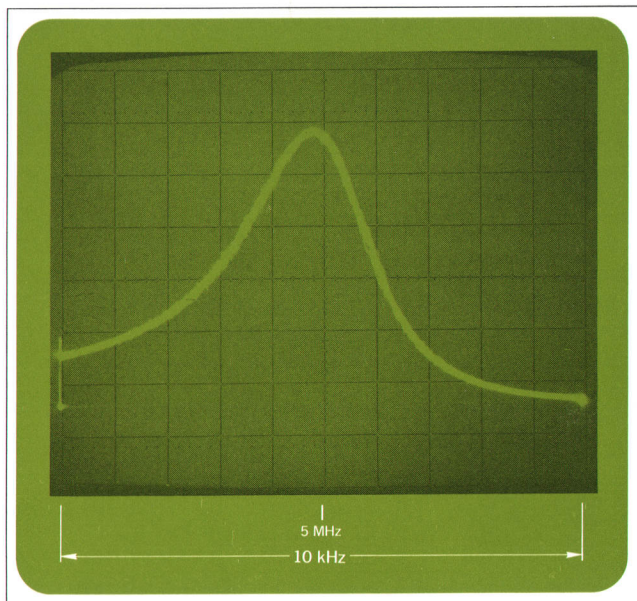

Fig. 6. The generator/sweeper's residual FM is low enough to make narrow sweeps feasible. This is the response of a 5-MHz crystal filter which has a 3-dB bandwidth of 3 kHz.

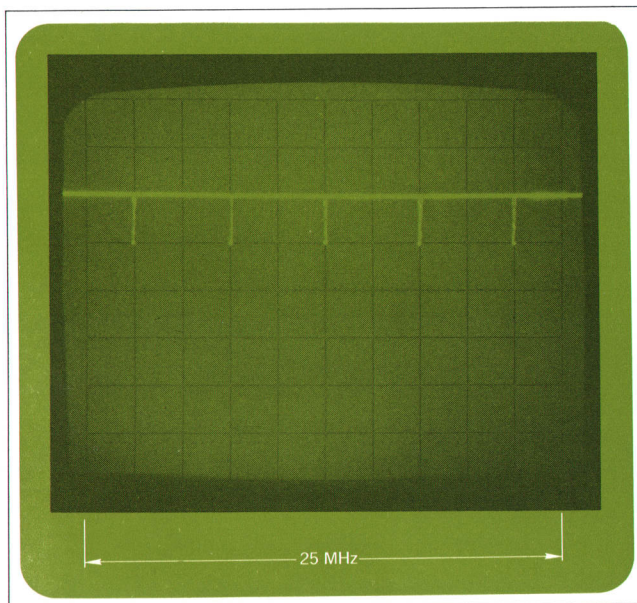

Fig. 7. The output of a built-in 5-MHz crystal calibrator and harmonic generator can be superimposed in the ALC loop to produce a dip in output power every 5 MHz. The marker frequencies are accurate within $\pm 0.01\%$. Between the calibrator markers, frequencies can be interpolated within $\pm 0.1\%$.

Together, the meter and the output attenuator can be used to set the output level anywhere between +20 dBm and -110 dBm. Settings below +13 dBm are accurate within ± 1 dB.

AFC for Stability and Linearity

Automatic frequency control is rarely found in broadband swept signal sources. In the new generator/sweeper, it works like this (see Fig. 2 again). The difference frequency of 0.1 to 110 MHz coming out of the main mixer is recreated in the loop mixer. On the high range (1 to 110 MHz) the output frequency of the loop mixer is divided by 10. On the low range (0.1 to 11 MHz) the divider is bypassed. On either range, therefore, the loop mixer and divider produce a 0.1-to-11-MHz signal. This signal goes to an extremely linear (within 0.5%) pulse-count discriminator which produces a voltage proportional to its input frequency. This voltage is then compared in a differential amplifier with a reference voltage coming either from the sweep generator or from the CW tuning circuits. Any difference between the actual frequency and the desired frequency appears as an error signal which retunes the voltage-tuned oscillator.

Because of the linearity of the pulse-count discriminator, the voltage-to-frequency characteristic of the generator/sweeper is linear within 0.5%.

Fig. 5 shows typical frequency-modulation rates and deviations which can be applied externally without exceeding 1% distortion. These characteristics are important in such applications as testing FM receivers. The FM input can also be used to program the output frequency remotely; this would be done if the instrument were part of an automatic test system.

Automatic frequency control significantly reduces the serious frequency instabilities inherent in heterodyne sources. As a result, frequency dial settings are accurate within $\pm 1\%$ of the output frequency. The tuning dial is linear and has high resolution (10 kHz on low range, 100 kHz on high range). Drift and residual FM are low (see Fig. 6 and specifications, page 19), low enough for narrow-band measurements that used to be possible only with manually tuned generators or relatively costly phase-locked sweepers.

Markers Not Needed

The frequency accuracy and linearity of the generator/sweeper eliminate the need for variable markers in broadband work. The instrument has five calibrated sweep widths which are accurate within $\pm 5\%$. When the SWEEP WIDTH control is in a calibrated position, the horizontal controls of an oscilloscope or an X-Y recorder

SPECIFICATIONS

HP Model 8601A Generator/Sweeper

Frequency Characteristics

COVERAGE:

Low range, 0.1–11 MHz.
High range, 1–110 MHz.

ACCURACY:

Low range, $\pm 1\%$ of frequency or ± 10 kHz, whichever is greater.
High range, $\pm 1\%$ of frequency or ± 100 kHz, whichever is greater.

LINEARITY:

$\pm 0.5\%$, full and video sweep.

DRIFT IN CW:

(0.01% +500 Hz)/10 min., high range after 1 hour warmup.
(0.01% +50 Hz)/10 min., low range, after 1 hour warm-up.
0.025%/°C temperature change.
0.001%/V line voltage change.

HARMONICS AND SPURIOUS SIGNALS (CW above 250 kHz, output levels below the +20 dBm attenuator step):

Harmonics at least 35 dB below carrier.
Spurious signals at least 40 dB below carrier.

RESIDUAL FM IN CW:

Noise in 10-kHz bandwidth including line-related components:

Less than 50 Hz rms, low range.
Less than 500 Hz rms, high range.

INCIDENTAL FM WITH 30% AM:

Less than 100 Hz peak, low range.
Less than 1 kHz peak, high range.
Incidental FM in CW is negligible.

RESIDUAL AM:

AM noise modulation index (rms, 10 kHz bandwidth) is < -50 dB. (Typically -60 dB at 25°C.)

INCIDENTAL AM:

Incidental AM modulation index is < -55 dB with 75 kHz deviation.

Output Characteristics

LEVEL: +20 to -110 dBm. 10-dB steps and 13-dB vernier provide continuous settings over entire range. Meter monitors output in dBm and rms volts into 50 Ω .

ACCURACY: ± 1 dB accuracy for any output level from +13 dBm to -110 dBm.

FLATNESS: ± 0.25 dB over full range, ± 0.1 dB over any 10-MHz portion.

IMPEDANCE: 50 Ω , SWR < 1.2 on 0 dBm step and below.

RF LEAKAGE: Low leakage permits receiver sensitivity measurements down to 1 microvolt.

Sweep Characteristics

FULL: Approximately 0.1–11 MHz and 1–110 MHz independent of dial setting.

VIDEO: Sweep extends from low end of range to frequency dial setting.

SYMMETRICAL: Center frequency may be tuned to any point on either range.

SWEEP WIDTH: 0 to 1 MHz low range; 0 to 10 MHz high range. There are 5 calibrated sweep width positions as well as an uncalibrated vernier to provide continuous adjustments.

SWEEP WIDTH ACCURACY: $\pm 5\%$ of sweep width or ± 1 kHz on low range; $\pm 5\%$ of sweep width or ± 10 kHz on high range, whichever is greater.

SWEEP SPEEDS: Fast, typically 6 to 60 sweeps per second, variable; Slow, typically 8 to 80 seconds per sweep, variable. Manual, continuous tuning over preset limits.

TRIGGER MODES: Manual trigger with reset, line-synchronized, or free-running.

Amplitude Modulation

INTERNAL AM: 30% $\pm 5\%$ at 1 kHz, less than 3% distortion. Typically $< 1\%$ distortion for output readings on upper half of meter scale.

EXTERNAL AM: 0 to 50%, up to 400 Hz. 0 to 30%, up to 1 kHz. Applied through external AM input on front panel.

Frequency Modulation

INTERNAL FM:

HIGH RANGE: 75 kHz $\pm 20\%$ peak deviation, 1-kHz rate.
LOW RANGE: 7.5 kHz $\pm 20\%$ peak deviation, 1-kHz rate.
Less than 3% distortion. Typically $< 1\%$.

EXTERNAL FM:

Deviations to the band edges are possible for rates to 100 Hz; voltage to frequency linearity is $\pm 0.5\%$, allowing remote frequency programming. FM rates to 10 kHz are obtainable with less linearity and accuracy.

Crystal Calibrator

Internal 5-MHz crystal allows frequency calibration to $\pm 0.01\%$ at any multiple of 5 MHz.

Auxiliary Outputs

FRONT PANEL:

SWEEP OUTPUT: approximately 0 to +7 volts.
AUXILIARY OUTPUT: always 0.1–11 MHz for low frequency counter monitoring.

REAR PANEL:

SWEEP REFERENCE OUTPUT: provides voltage analog to frequency output.

UNCALIBRATED RF OUTPUT: -5 dBm minimum, unmodulated.

VTO OUTPUT: 200.1 to 310 MHz.

BLANKING: -4 volt pulse concurrent with RF blanking

General

POWER: 115 or 230 V, $\pm 10\%$, 50 to 400 Hz, $\pm 10\%$; approximately 50 watts.

WEIGHT: Net, 21 lb (9.5 kg). Shipping, 27 lb (12.3 kg).

DIMENSIONS: 7 $\frac{1}{2}$ in wide, 6 $\frac{1}{2}$ in high, 16 $\frac{1}{2}$ in deep (190 x 155 x 416 mm).

PRICE: Model 8601A, \$1,975.00.

MANUFACTURING DIVISION: MICROWAVE DIVISION

1501 Page Mill Road
Palo Alto, California 94304

can be adjusted to make the ends of the sweep coincide with graticule or scale markings, and the display will then be calibrated in MHz/cm, MHz/in, or whatever scale factor is desired. The display will be linear within the combined accuracy of the generator/sweeper and the display device. Thus when frequency accuracy within one or two percent is sufficient, no markers are needed, the

display is much cleaner, and no additional equipment to generate the markers is required.

Even when greater frequency accuracy is needed, such as that normally obtainable only with crystal markers, it can be obtained without markers by using a counter on the discriminator input, which is brought out to the front panel. The frequency of this signal is always 0.1 to 11



John R. Hearn (right) was project supervisor for the 8601A Generator/Sweeper. He joined HP in 1962 as the first research and development engineer at Hewlett-Packard Limited (now located in Scotland). In 1964 he became chief engineer at HP Ltd.

John graduated from the University of Southampton in 1956 with the degree B. Sc. Special (Honours) in physics. Before coming to HP he worked on vibration analysis and instrumentation of developmental aircraft gas turbines. He holds two patents related to gas-turbine instrumentation. John is now a project supervisor in the HP Microwave Division engineering lab, Palo Alto.

Douglas C. Spreng (left) is concerned with marketing the 8601A Generator/Sweeper. Doug is an applications engineer for the signal generator and sweeper section of the Microwave Division. He joined HP in 1967 after receiving a Master's degree in Business Administration from the Harvard Business School. Doug received his BSEE from MIT in 1965 and was elected to Eta Kappa Nu and Tau Beta Pi.

MHz; therefore it can be measured by a low-cost counter. In this way frequencies up to 110 MHz can be determined within 0.001%. Using this capability in the generator/sweeper's manual mode gives accuracies comparable to those of crystal markers without the markers' disadvantage of confining one to fixed frequencies.

For intermediate accuracy, that is, better than dial accuracy but not so good as counter accuracy, the generator/sweeper has a crystal calibrator. A 5-MHz crystal signal is mixed with the recreated RF frequencies in the loop mixer and is superimposed in the ALC loop, causing a dip in output power at 5-MHz intervals. The calibrator is accurate within 0.01% at 5-MHz intervals and the instrument's linearity allows interpolation within 0.1% at all frequencies in the band (see Fig. 7).

Modular Construction

Small component size has made it possible to package the RF sections of the instrument in individual modules. Two major benefits ensue. First, RFI leakage can be kept extremely low by running shielded transmission lines between modules. The generator/sweeper's RFI leakage is so low that it can provide input levels as low as one microvolt in receiver sensitivity measurements without RFI degradation. Second, modular packaging simplifies troubleshooting and servicing; malfunctioning modules can be identified and replaced rapidly.

Dual Performance

Because of its dual performance the generator/sweeper can make measurements which formerly required two instruments. In many instances it can do a better job than any one instrument could do before. For example, a medium-grade FM receiver can be aligned by sweeping the IF circuits and the discriminator directly through the front end, and then tested for sensitivity and quieting down to a microvolt, all with the same signal source. As another example, a breadboarded IF strip and discriminator being developed in the laboratory can be tested for gain, flatness, bandwidth, total system linearity, and sensitivity to AM and FM, all with one signal source.

The generator/sweeper can also be a tracking generator for the new spectrum analyzer discussed in this issue. The voltage tuned oscillator of the generator/sweeper is identical to the first local oscillator of the spectrum analyzer. The combination can make swept frequency-response measurements with 70-dB display range, over the frequency range of the generator/sweeper, 0.1 to 110 MHz (see 'Analyzer/Tracking-Generator System,' p. 4).

Acknowledgments

Full-time members of the design group for the 8601A Generator/Sweeper were: Phillip G. Foster—product design, Pierre M. Ollivier—sweep and timing circuits, R. Frederick Rawson—ALC, thin-film, and divider circuits, Chester G. Haibel, Jr.—AFC and VTO. Other invaluable contributions were made by George E. Bodway, Elwood H. Barlow, Patrick H. Y. Wang, and S. Jack Magri. 

Units Ambiguity Noted

Editor, Hewlett-Packard Journal:

On the back cover of your February 1968 issue, you give W/mK as the symbol for "watt per meter kelvin." Unfortunately, the close coupling between the m and K results in "millikelvin." The General Conference carefully left a space between m and K in the mimeographed copies of their resolution.

All USASI standards on letter symbols now carry an introductory section "General Principles of Letter Symbol Standardization." In this section, the problem is resolved as follows:

"When a compound unit is formed by multiplication of two or more other units, its symbol consists of the symbols for the separate units joined by a raised dot (for example N·m for newton meter). The dot may be omitted in the case of familiar compounds such as watthour (symbol Wh) if no confusion would result."

Sincerely,
Chester H. Page
 National Bureau of Standards
 Washington, D.C.
 Chairman, USASI/Y10

Here is the corrected table of derived units added to the International System of Units by the 13th General Conference on Weights and Measures.*

Quantity	Derived Unit	Symbol
Wave number	1 per meter	m ⁻¹
Entropy	joule per kelvin	J/K
Specific Heat	joule per kilogram kelvin	J/kgK
Thermal conductivity	watt per meter kelvin	W/m·K
Radiant intensity	watt per steradian	W/sr
Activity (of a radioactive source)	1 per second	s ⁻¹

*Originally printed in 'Atomic Second Adopted by International Conference,' 'Hewlett-Packard Journal,' Vol. 19, No. 6, Feb. 1968.